



KATALOG PRODUKTÓW

Półki samowiszące

Półki laminowane

Półki modułowe

System Goliat

Wsporniki ozdobne

Wsporniki proste

Wsporniki techniczne

Haki garażowe

Systemy regałowe

Wieszaki ubrań

Velano

wyposażenie wnętrz

Produkty Velano pozwolą Ci na ekspresję i swobodę w aranżacji wnętrz. Z powodzeniem możesz je zastosować w domu, biurze, warsztacie czy garażu. Daj się ponieść wyobraźni i stwórz funkcjonalne oraz wyjątkowe wnętrze.

PÓŁKI samowiszące



biała
buk
jabłoń
wenge
dąb
olcha
dąb sonoma
congo
szara
czarna
biała
wysoki
połysk

Półka samowisząca FS

symbol	nr art.	kolor	wymiary [mm]
FS 24/24 BI	65050	biała	235 × 235
FS 60/24 BI	65080	biała	595 × 235
FS 80/24 BI	65110	biała	795 × 235
FS 118/24 BI	65140	biała	1180 × 235

FS 24/24 BK	65051	buk	235 × 235
FS 60/24 BK	65081	buk	595 × 235
FS 80/24 BK	65111	buk	795 × 235
FS 118/24 BK	65141	buk	1180 × 235

FS 24/24 JB	65052	jabłoń	235 × 235
FS 60/24 JB	65082	jabłoń	595 × 235
FS 80/24 JB	65112	jabłoń	795 × 235
FS 118/24 JB	65142	jabłoń	1180 × 235

FS 24/24 WE	65054	wenge	235 × 235
FS 60/24 WE	65084	wenge	595 × 235
FS 80/24 WE	65114	wenge	795 × 235
FS 118/24 WE	65144	wenge	1180 × 235

FS 24/24 D	65055	dąb	235 × 235
FS 60/24 D	65085	dąb	595 × 235
FS 80/24 D	65115	dąb	795 × 235
FS 118/24 D	65145	dąb	1180 × 235

FS 24/24 OL	65056	olcha	235 × 235
FS 60/24 OL	65086	olcha	595 × 235
FS 80/24 OL	65116	olcha	795 × 235
FS 118/24 OL	65146	olcha	1180 × 235

FS 24/24 DS	65057	dąb sonoma	235 × 235
FS 60/24 DS	65087	dąb sonoma	595 × 235
FS 80/24 DS	65117	dąb sonoma	795 × 235
FS 118/24 DS	65147	dąb sonoma	1180 × 235

FS 24/24 CG	65060	congo	235 × 235
FS 60/24 CG	65090	congo	595 × 235
FS 80/24 CG	65120	congo	795 × 235
FS 118/24 CG	65150	congo	1180 × 235

FS 24/24 SZ	65061	szara	235 × 235
FS 60/24 SZ	65091	szara	595 × 235
FS 80/24 SZ	65121	szara	795 × 235
FS 118/24 SZ	65151	szara	1180 × 235

FS 24/24 C	65062	czarna	235 × 235
FS 60/24 C	65092	czarna	595 × 235
FS 80/24 C	65122	czarna	795 × 235
FS 118/24 C	65152	czarna	1180 × 235

Półka samowisząca wysoki połysk FSG

symbol	nr art.	kolor	wymiary [mm]
FSG 235/235 BI	65070	biała	235 × 235
FSG 595/235 BI	65100	biała	595 × 235
FSG 795/235 BI	65130	biała	795 × 235
FSG 1180/235 BI	65160	biała	1180 × 235



Półka laminowana narożna

symbol	nr art.	kolor	wymiary [mm]
LSC 25/25 BK	63021	buk	250 × 250
LSC 35/35 BK	63031	buk	350 × 350

LSC 25/25 JB	63022	jabłoń	250 × 250
LSC 35/35 JB	63032	jabłoń	350 × 350

LSC 25/25 D	63025	dąb	250 × 250
LSC 35/35 D	63035	dąb	350 × 350



PÓŁKI laminowane

Półka laminowana

symbol	nr art.	kolor	wymiary [mm]
LSR 60/15 BK	63311	buk	600 × 150
LSR 60/25 BK	63321	buk	600 × 250
LSR 60/35 BK	63331	buk	600 × 350
LSR 80/25 BK	63351	buk	800 × 250
LSR 80/35 BK	63361	buk	800 × 350

LSR 60/15 JB	63312	jabłoń	600 × 150
LSR 60/25 JB	63322	jabłoń	600 × 250
LSR 60/35 JB	63332	jabłoń	600 × 350
LSR 80/25 JB	63352	jabłoń	800 × 250
LSR 80/35 JB	63362	jabłoń	800 × 350

LSR 60/15 D	63315	dąb	600 × 150
LSR 60/25 D	63325	dąb	600 × 250
LSR 60/35 D	63335	dąb	600 × 350
LSR 80/25 D	63355	dąb	800 × 250
LSR 80/35 D	63365	dąb	800 × 350

Półka laminowana prostokątna

symbol	nr art.	kolor	wymiary [mm]
LSS 60/15 BK	63111	buk	600 × 150
LSS 60/25 BK	63121	buk	600 × 250
LSS 80/25 BK	63141	buk	800 × 250

LSS 60/15 JB	63112	jabłoń	600 × 150
LSS 60/25 JB	63122	jabłoń	600 × 250
LSS 80/25 JB	63142	jabłoń	800 × 250

LSS 60/15 D	63115	dąb	600 × 150
LSS 60/25 D	63125	dąb	600 × 250
LSS 80/25 D	63145	dąb	800 × 250

LSS 80/25 BI	63250	biała	800 × 250
LSS 80/30 BI	63260	biała	800 × 300
LSS 80/35 BI	63270	biała	800 × 350

LSS 80/25 SZ	63257	szara	800 × 250
LSS 80/30 SZ	63267	szara	800 × 300
LSS 80/35 SZ	63277	szara	800 × 350



FSS

symbol	nr art.	kolor	opakowanie zbiorcze
FSS 100 Półka BI, 3 szt. kpl.	67221	biała	1
FSS 100 Półka SZ, 3 szt. kpl.	67222	szara	1
FSS 100 Półka DS, 3 szt. kpl.	67223	dąb sonoma	1
FSS 100 Półka WE, 3 szt. kpl.	67224	wenge	1

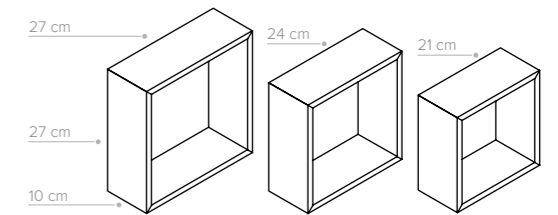

FUS

symbol	nr art.	kolor	opakowanie zbiorcze
FUS 1 Półka BI, 3 szt. kpl.	67111	biała	1
FUS 1 Półka SZ, 3 szt. kpl.	67112	szara	1
FUS 1 Półka DS, 3 szt. kpl.	67113	dąb sonoma	1
FUS 1 Półka WE, 3 szt. kpl.	67114	wenge	1

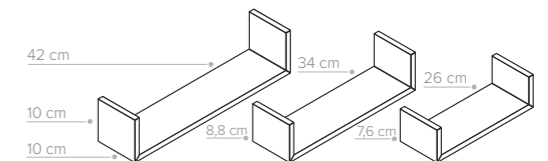

PÓŁKI modułowe

symbol	nr art.	kolor	opakowanie zbiorcze
FIS 1 Półka BI, 3 szt. kpl.	67311	biała	1
FIS 1 Półka SZ, 3 szt. kpl.	67312	szara	1
FIS 1 Półka DS, 3 szt. kpl.	67313	dąb sonoma	1
FIS 1 Półka WE, 3 szt. kpl.	67314	wenge	1

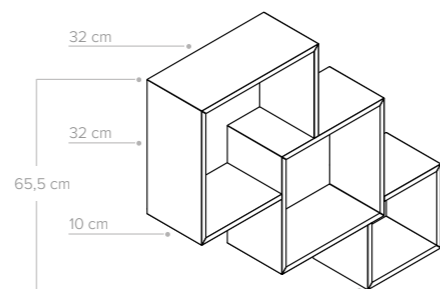

FOS

symbol	wymiary [cm]	nr art.	kolor	opakowanie zbiorcze
FOS 1 Półka BI, 3 szt. kpl.	40/35/30	67101	biała	1



FIS

symbol	nr art.	kolor	opakowanie zbiorcze
FRS 1 Półka BI, 3 szt. kpl.	67911	biała	1
FRS 1 Półka SZ, 3 szt. kpl.	67912	szara	1
FRS 1 Półka DS, 3 szt. kpl.	67913	dąb sonoma	1
FRS 1 Półka WE, 3 szt. kpl.	67914	wenge	1

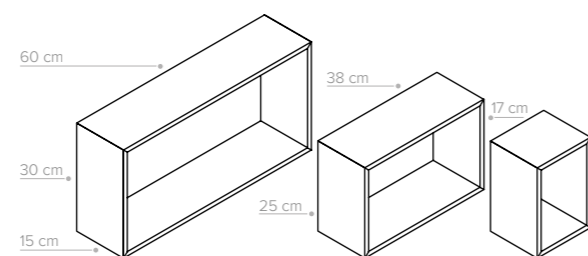

FRS





system GOLIAT



symbol	nr art.	wymiary [mm]	
		a	b
SGK1 Haki 9 części	5866	600	100
SGH1 hak	5873	200	75
SGH2 hak	5874	240	75
SGH3 hak	5875	130	210
SGH4 hak	5876	220	75
SGH5 hak	5877	175	80
SGH6 hak	5878	265	75
SGH7 hak	5879	207	205
SGH8 hak	5880	190	38
SGH9 hak	5881	140	38
SGH10 hak	5882	58	38
SGH11 hak	5883	230	80
SGH12 hak	5884	145	75
SGH13 hak	5885	270	76
SGH14 hak	5886	145	38
SGH15 hak	5887	210	120
SGS Szyna	5870	600	
SGL Łącznik	5871		
SGM Maskownica L+P	5872		

symbol	nr art.	wymiary [cm]
		a
SGR uchwyt na rower	5897	43
SGO wspornik na opony	5898	81-120



SGK 1
Zestaw Haków
Garażowych

W skład zestawu wchodzi:

- szyna mocująca do ściany SGS (2 sztuki),
- łącznik szyny SGL,
- maskownica lewa i prawa SGM,
- haki: SGH 1 (2 sztuki), SGH 2, SGH 6, SGH 7 i SGH 10.

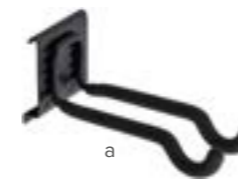

SGH1



SGH2

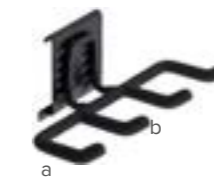

SGH3



SGH4



SGH5



SGH6

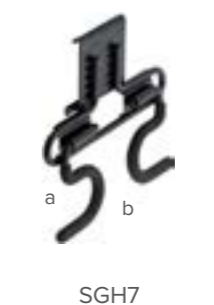

SGH7



SGH8

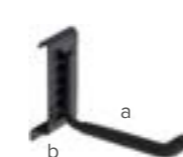

SGH9



SGH10

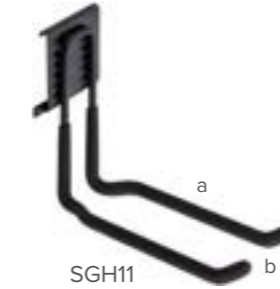

SGH11



SGH12



SGH13



SGH14

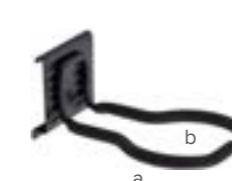

SGH15



SGS



SGL



SGM



SGR

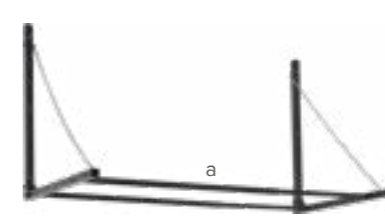

SGO





wsporniki OZDOBNE

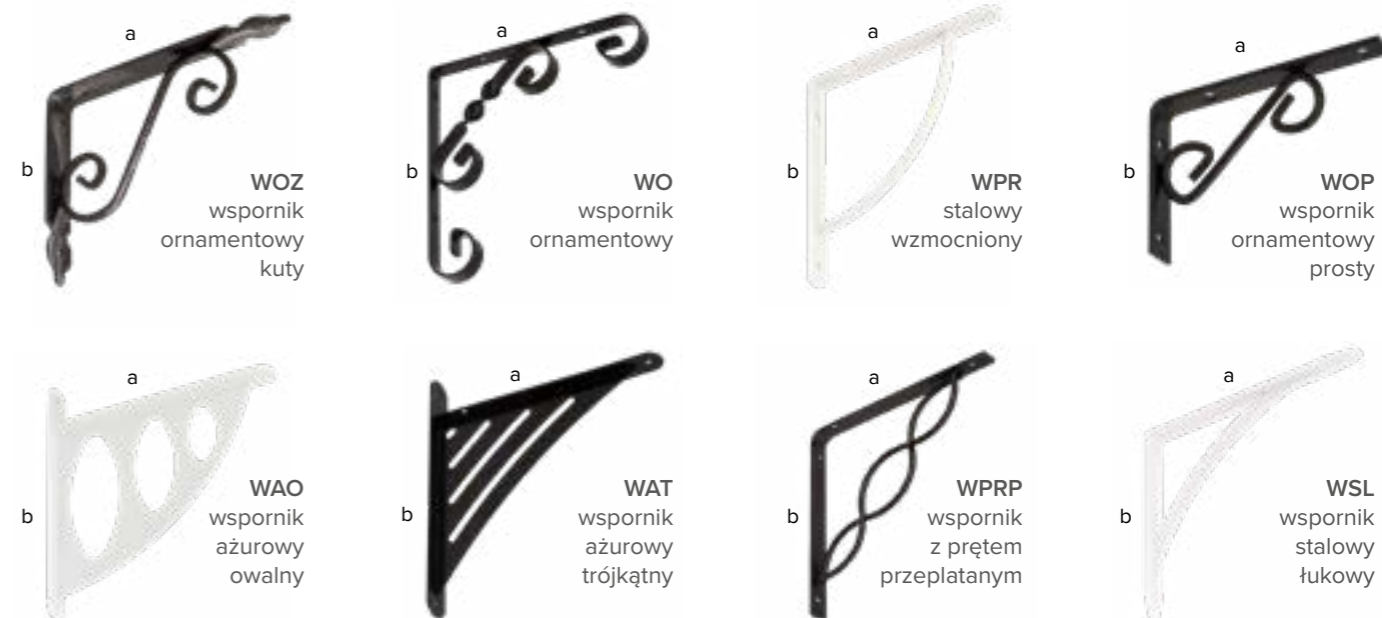

Wsporniki
ozdobne

symbol	nr art.	kolor	wymiary [mm]	
			a	b
WOZ 140 HC	5920	czarny*	140	110
WOZ 190 HC	5921	czarny*	190	140
WOZ 240 HC	5922	czarny*	240	190
WOZ 140 HSR	5923	srebrny*	140	110
WOZ 190 HSR	5924	srebrny*	190	140
WOZ 240 HSR	5925	srebrny*	240	190
WOZ 140 ASR	5926	czarno-srebrny	140	110
WOZ 190 ASR	5927	czarno-srebrny	190	140
WOZ 240 ASR	5928	czarno-srebrny	240	190
WO 100 C	5262	czarny	100	
WO 150 C	5272	czarny	150	150
WO 200 C	5282	czarny	200	200
WO 250 C	5292	czarny	250	250
WPR 150 BI	5250	biały	150	150
WPR 185 BI	5253	biały	185	185
WPR 220 BI	5256	biały	220	220
WPR 150 CH	5252	szary	150	150
WPR 185 CH	5255	szary	185	185
WPR 220 CH	5258	szary	220	220
WOP 150 BI	5265	biały	150	100
WOP 150 C	5266	czarny	150	100
WOP 200 BI	5267	biały	200	125
WOP 200 C	5268	czarny	200	125
WOP 250 BI	5269	biały	250	125
WOP 250 C	5270	czarny	250	125
WAO 190 BI	5246	biały	194	200
WAO 190 C	5247	czarny	194	200
WAT 190 BI	5248	biały	194	200
WAT 190 C	5249	czarny	194	200
WPRP 150 BI	5234	biały	150	150
WPRP 200 BI	5236	biały	200	200
WPRP 150 C	5235	czarny	150	150
WPRP 200 C	5237	czarny	200	200
WSL 175 BI	5232	biały	175	125
WSL 250 BI	5233	biały	250	200

* powierzchnia gradowana

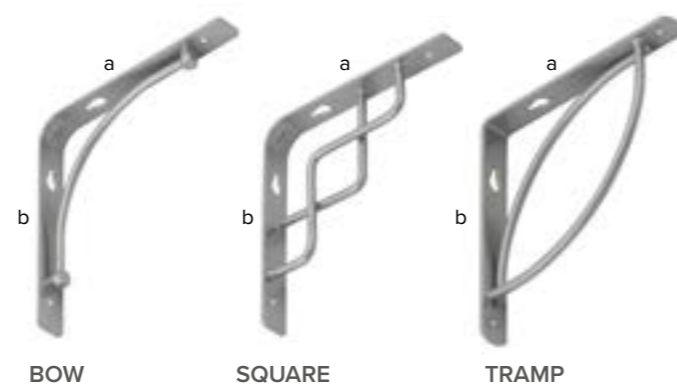

Wsporniki ozdobne stalowe

symbol	nr art.	kolor	wymiary [mm]	
			a	b
BOW 150 CMT	5650	czarny matowy	150	150
BOW 150 SRMT	5651	srebrny matowy	150	150
BOW 200 CMT	5655	czarny matowy	200	200
BOW 200 SRMT	5656	srebrny matowy	200	200
SQUARE 150 CMT	5660	czarny matowy	150	150
SQUARE 150 SRMT	5661	srebrny matowy	150	150
SQUARE 200 CMT	5665	czarny matowy	200	200
SQUARE 200 SRMT	5666	srebrny matowy	200	200
TRAMP 150 SRMT	5671	srebrny matowy	150	150
TRAMP 200 SRMT	5676	srebrny matowy	200	200



wsporniki PROSTE



Wsporniki proste

symbol	nr art.	kolor	wymiary [mm]	
			a	b
WWPS 150 BI	5910	biały	150	150
WWPS 200 BI	5912	biały	200	200
WWPS 250 BI	5914	biały	250	250

WSPP 115 BI	5401	biały	115	78
WSPP 180 BI	5405	biały	180	115
WSPP 240 BI	5409	biały	240	145
WSPP 115 BR	5404	brązowy	115	78
WSPP 180 BR	5408	brązowy	180	115
WSPP 240 BR	5412	brązowy	240	145

WSM 30 BI	5155	biały	30	30
WSM 50 BI	5156	biały	50	30
WSM 75 BI	5157	biały	75	75
WSM 100 BI	5158	biały	100	100
WSM 130 BI	5159	biały	130	130
WSM 30 ZN	5145	ocynk	30	30
WSM 50 ZN	5146	ocynk	50	50
WSM 75 ZN	5147	ocynk	75	75
WSM 100 ZN	5148	ocynk	100	100
WSM 130 ZN	5149	ocynk	130	130

WSB 150 BI	5121	biały	150	125
WSB 200 BI	5131	biały	200	150
WSB 250 BI	5141	biały	250	200
WSB 300 BI	5151	biały	300	250
WSB 150 C	5122	czarny	150	125
WSB 200 C	5132	czarny	200	150
WSB 250 C	5142	czarny	250	200



WSB
wspornik
stalowy

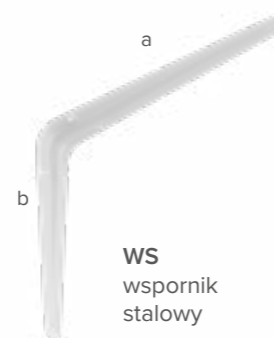

WS
wspornik
stalowy

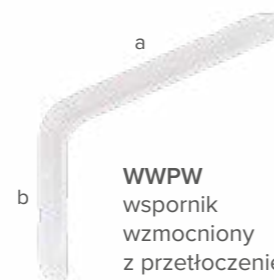

WWPW
wspornik
wzmocniony
z przetłoczeniem

symbol	nr art.	kolor	wymiary [mm]	
			a	b
WS 100 BI	5011	biały	100	75
WS 125 BI	5021	biały	125	100
WS 150 BI	5031	biały	150	125
WS 175 BI	5041	biały	175	125
WS 200 BI	5051	biały	200	150
WS 225 1 BI	5055	biały	225	175
WS 225 2 BI	5061	biały	225	200
WS 250 BI	5071	biały	250	200
WS 300 BI	5081	biały	300	250
WS 350 BI	5091	biały	350	300
WS 400 BI	5101	biały	400	350
WS 450 BI	5111	biały	450	400
WS 100 BR	5012	brązowy	100	75
WS 125 BR	5022	brązowy	125	100
WS 150 BR	5032	brązowy	150	125
WS 175 BR	5042	brązowy	175	150
WS 200 BR	5052	brązowy	200	150
WS 225 BR 1	5056	brązowy	225	175
WS 225 BR 2	5062	brązowy	225	200
WS 250 BR	5072	brązowy	250	200
WS 300 BR	5082	brązowy	300	250
WS 350 BR	5092	brązowy	350	300
WS 400 BR	5102	brązowy	400	350
WS 450 BR	5112	brązowy	450	400
WS 100 S	5014	szary	100	75
WS 125 S	5024	szary	125	100
WS 150 S	5034	szary	150	125
WS 175 S	5044	szary	175	150
WS 200 S	5054	szary	200	150
WS 225 S 1	5058	szary	225	175
WS 225 S 2	5064	szary	225	200
WS 250 S	5074	szary	250	200
WS 300 S	5084	szary	300	250
WS 350 S	5094	szary	350	300
WS 400 S	5104	szary	400	350
WS 450 S	5114	szary	450	400
WWPW 200 BI	5113	biały	200	140
WWPW 250 BI	5115	biały	250	180
WWPW 300 B	5117	biały	300	200



wsporniki TECHNICZNE

Wsporniki techniczne stalowe

symbol	nr art.	kolor	wymiary [mm]	
			a	b
WSC 200 CH	5901	chrom	200	135
WSC 350 CH	5902	chrom	350	135

WSA 250 CH	5899	chrom	250	145
WSA 300 CH	5900	chrom	300	145

WSN 300 BI	5908	biały	300	130
WSN 400 BI	5909	biały	400	160

WSR 300 BI	5230	biały	300-460	220
------------	------	-------	---------	-----

WSZ 300 BI	5903	biały	300	300
WSZ 400 BI	5904	biały	400	300
WSZ 300 SR	5905	srebrny	300	300
WSZ 400 SR	5906	srebrny	400	300

WSZL 200 BI	5295	biały	200	200
WSZL 300 BI	5296	biały	300	300

WSWP 300 BI	5194	biały	300	200
WSWP 400 BI	5196	biały	400	250
WSWP 500 BI	5198	biały	500	330
WSWP 300 SZ	5350	szary	300	200
WSWP 400 SZ	5351	szary	400	250
WSWP 500 SZ	5352	szary	500	330
WSWP 300 C	5353	czarny	300	200
WSWP 400 C	5354	czarny	400	250
WSWP 500 C	5355	czarny	500	330
WSWP 300 ZN	5195	cynk jasny	300	200
WSWP 400 ZN	5197	cynk jasny	400	250
WSWP 500 ZN	5199	cynk jasny	500	330

HMUN 150	5855	ocynk	150	198
HMUN 250	5856	ocynk	250	256
HMUN 350	5857	ocynk	350	313



WDG
wspornik ze
sklejki giętej



WDGL
wspornik ze
sklejki giętej
lekki



WDW
wspornik
drewniany
wzmocniony



WDP
wspornik
drewniany
płaski

Wsporniki techniczne drewniane

symbol	nr art.	kolor	wymiary [mm]	
			a	b
WDG 150	5210	sklejka	150	100
WDG 200	5211	sklejka	200	150
WDG 250	5212	sklejka	250	200

WDGL 150	5214	sklejka	150	100
WDGL 200	5216	sklejka	200	150
WDGL 250	5218	sklejka	250	200

WDW 230 BK	5220	buk	230	170
WDW 280 BK	5222	buk	280	230
WDW 320 BK	5224	buk	320	280
WDW 230 SO	5221	sosna	230	170
WDW 280 SO	5223	sosna	280	230
WDW 320 SO	5225	sosna	320	280

WDP 165 SO	5226	sosna	165	95
WDP 215 SO	5227	sosna	215	120
WDP 260 SO	5228	sosna	260	135

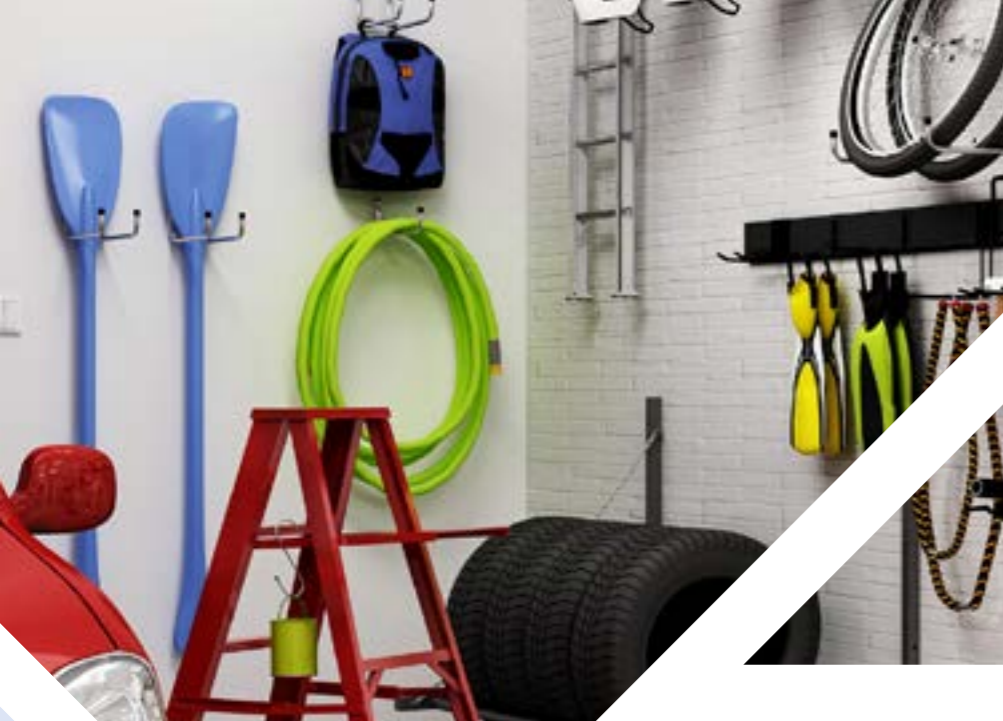

HAKI garażowe

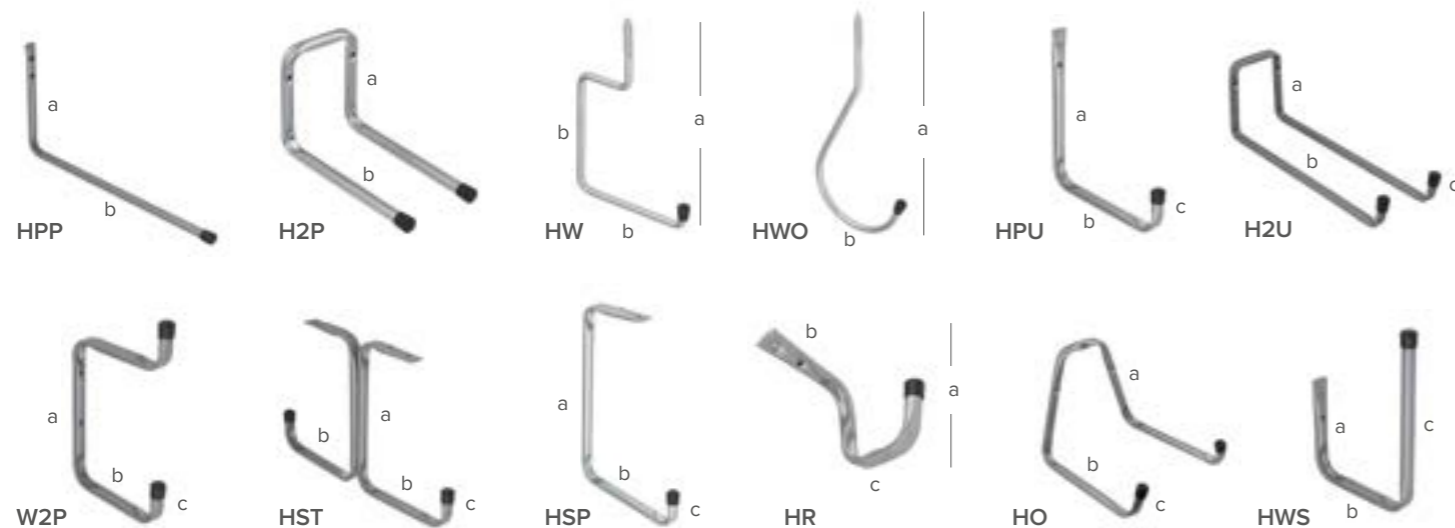

symbol	nr art.	wymiar [mm]	
		a	b
HDS 200	5863	200	58
HDS 500	5864	500	58
HDS 800	5865	800	58
HMU	8878	46	36
HMU 90	5851	90	30
HMU 110	5852	110	60
HMU 180	5853	180	100
HPP 180	5801	90	180
HPP 250	5802	170	250
HPP 350	5803	170	350
H2P 180	5821	120	180
HW	5841	170	110
HWO	5842	210	85



symbol	nr art.	wymiar [mm]		
		a	b	c
HPU 80	5811	120	80	55
HPU 120	5812	140	120	55
HPU 160	5813	200	160	80
HPU 200	5814	300	200	80
HPU 260	5815	300	260	100
H2U 80	5822	120	80	50
H2U 160	5823	120	160	50
H2U 220	5824	120	220	50
H2U 300	5825	120	300	50
W2P 200	5831	250	200	90
HST 300	5832	300	230	90
HSP 260	5833	390	260	90
HR 120	5834	120	180	120
HO 300	5835	250	300	90
HWS 200	5836	180	200	280



SYSTEMY regałowe

symbol	nr art.	kolor	wymiar [mm]
			a
WLD 500 BI	5458	biały	500
WLD 500 SZ	5459	szary	500
WLD 1000 BI	5460	biały	1000
WLD 1000 SZ	5461	szary	1000
WLD 1500 BI	5462	biały	1500
WLD 1500 SZ	5463	szary	1500
WLD 2000 BI	5464	biały	2000
WLD 2000 SZ	5465	szary	2000

WSD 170 BI	5480	biały	170
WSD 170 SZ	5481	szary	170
WSD 220 BI	5482	biały	220
WSD 220 SZ	5483	szary	220
WSD 270 BI	5484	biały	270
WSD 270 SZ	5485	szary	270
WSD 370 BI	5486	biały	370
WSD 370 SZ	5487	szary	370
WSD 470 BI	5488	biały	470
WSD 470 SZ	5489	szary	470
WDO	5492	szary	31

symbol	nr art.	kolor
WKS 1 BI	5690	biały
WKS 1 SZ	5691	szary
WKS 2 BI	5692	biały
WKS 2 SZ	5693	szary
WKS 3 BI	5694	biały
WKS 3 SZ	5695	szary
WKS 4 BI	5696	biały
WKS 4 SZ	5697	szary



symbol	nr art.	kolor	wymiar [mm]
			a
WLS 150 BI	5493	biały	150
WLS 150 SZ	5494	szary	150
WLS 500 BI	5450	biały	500
WLS 500 SZ	5451	szary	500
WLS 1000 BI	5452	biały	1000
WLS 1000 SZ	5453	szary	1000
WLS 1500 BI	5454	biały	1500
WLS 1500 SZ	5455	szary	1500
WLS 2000 BI	5456	biały	2000
WLS 2000 SZ	5457	szary	2000

WSS 200 BI	5466	biały	200
WSS 200 SZ	5467	szary	200
WSS 250 BI	5468	biały	250
WSS 250 SZ	5469	szary	250
WSS 300 BI	5470	biały	300
WSS 300 SZ	5471	szary	300
WSS 350 BI	5472	biały	350
WSS 350 SZ	5473	szary	350
WSS 400 BI	5474	biały	400
WSS 400 SZ	5475	szary	400
WSS 500 BI	5476	biały	500
WSS 500 SZ	5477	szary	500
WSS 600 BI	5478	biały	600
WSS 600 SZ	5479	szary	600

WSK 180 BI	5680	biały	180
WSK 180 SZ	5681	szary	180
WSK 280 BI	5682	biały	280
WSK 280 SZ	5683	szary	280
WSK 380 BI	5684	biały	380
WSK 380 SZ	5685	szary	380
WSK 480 BI	5686	biały	480
WSK 480 SZ	5687	szary	480

WSJ	5490	szary	25
WSO	5491	szary	45



WIESZAKI ubrań

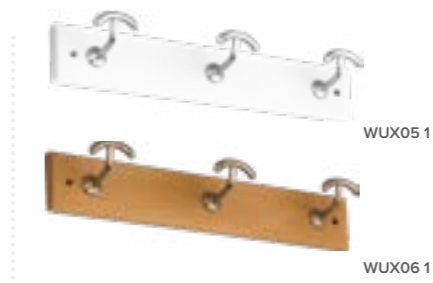
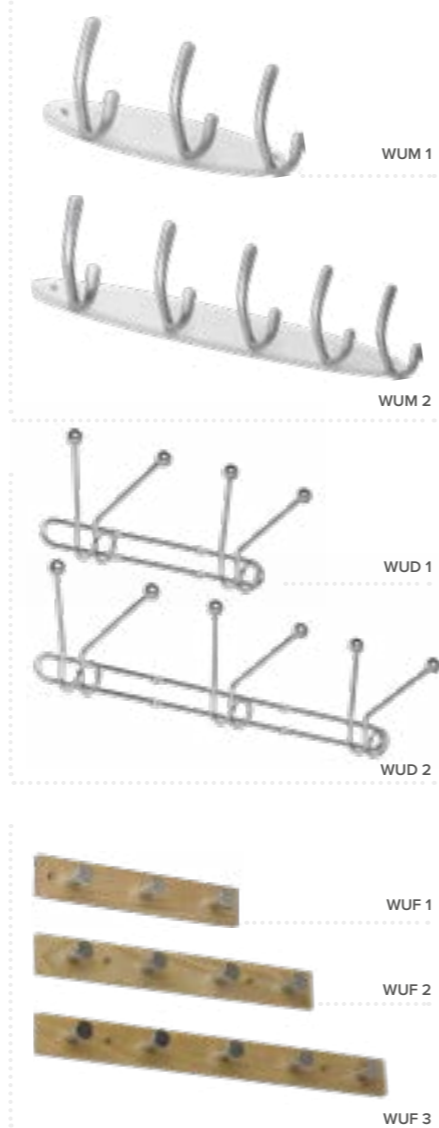
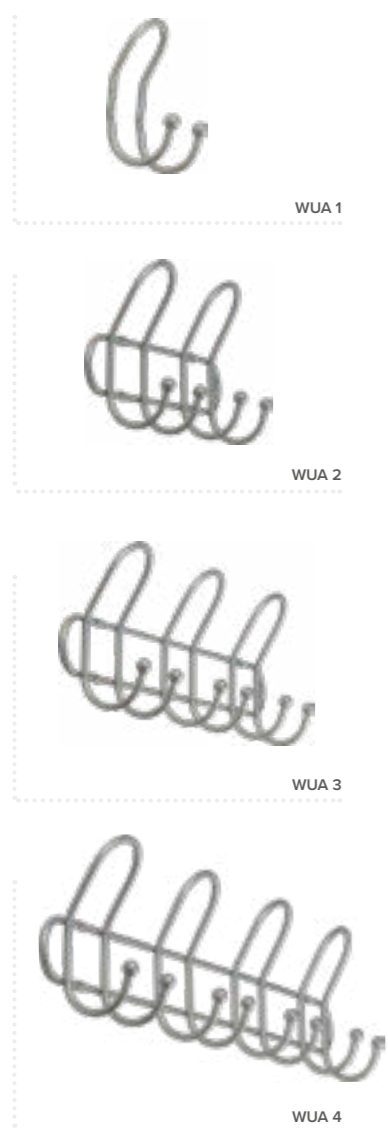

symbol	nr art.	wymiary [mm]
WUA 1	54401	50
WUA 2	54402	240
WUA 3	54403	390
WUA 4	54404	550
WUC 1	54421	320
WUC 2	54422	540
WUM 1	54331	320
WUM 2	54332	540
WUB 1	54411	300
WUB 2	54412	420
WUD 1	54431	350
WUD 2	54432	500
WUE 1	54441	250 x 50
WUE 2	54442	350 x 50
WUE 3	54443	450 x 50
WUF 1	54451	240 x 40
WUF 2	54452	325 x 40
WUF 3	54453	410 x 40
WUG 1	54461	150 x 120
WUG 2	54462	430 x 120
WUG 3	54463	750 x 120



WUX18 1



WUX19 1



WUX20 1



WUX21 1



WUX22 1



WUX23 1



WUX24 1



WUX25 1



WUX25 2



WUX26 1



WUX26 2

WUX27 1



WUX27 2



WUX27 3

WUX28 1



WUX28 2



WUX28 3

WUX29 1



WUX29 2



WUX29 3



WUX30 1



WUX30 2



WUX31 1

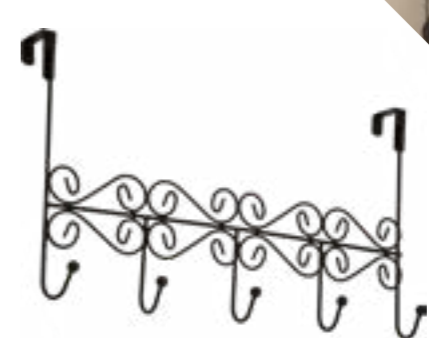

WUX31 2



WUX32 1



WUX33 1



WUX34 1



WUX35 1

symbol	nr art.	wymiary [mm]
WUX01 1	552011	410 x 50
WUX01 2	552012	560 x 50
WUX02 1	552021	410 x 50
WUX02 2	552022	560 x 50
WUX03 1	552031	420 x 60
WUX03 2	552032	520 x 60
WUX04 1	552041	420 x 60
WUX04 2	552042	520 x 60
WUX05 1	552051	340 x 60
WUX06 1	552061	340 x 60
WUX07 1	552071	500 x 60
WUX08 1	552081	500 x 60
WUX09 1	552091	500 x 60
WUX10 1	552101	500 x 60
WUX11 1	552111	330 x 110
WUX12 1	552121	330 x 110
WUX13 1	552131	330 x 110
WUX13 2	552132	440 x 110
WUX14 1	552141	330 x 110
WUX14 2	552142	440 x 110
WUX15 1	552151	375 x 60
WUX16 1	552161	375 x 60
WUX17 1	552171	374 x 67
WUX17 2	552172	374 x 67
WUX18 1	552181	380 x 160
WUX19 1	552191	580 x 240
WUX20 1	552201	370 x 180 x 40
WUX21 1	552211	260 x 180 x 40
WUX22 1	552221	260 x 160
WUX23 1	552231	45 x 130 x 40
WUX24 1	552241	485 x 220 x 40
WUX25 1	552251	345 x 60
WUX25 2	552252	455 x 40
WUX26 1	552261	350 x 150
WUX26 2	552262	580 x 150
WUX27 1	552271	215 x 140
WUX27 2	552272	460 x 150
WUX27 3	552273	700 x 150
WUX28 1	552281	220 x 80
WUX28 2	552282	300 x 80
WUX28 3	552283	380 x 80
WUX29 1	552291	220 x 150
WUX29 2	552292	380 x 150
WUX29 3	552293	540 x 150
WUX30 1	552301	400 x 40
WUX30 2	552302	600 x 40
WUX31 1	552311	410 x 270 x 40
WUX31 2	552312	450 x 145 x 40
WUX32 1	552321	540 x 45
WUX33 1	552331	35 x 150
WUX34 1	552341	255 x 155 x 40
WUX35 1	552351	480 x 80



Domax Sp. z o.o.

al. Parku Krajobrazowego 109

Łężyce, 84-207 Koleczkowo

tel. +48 58 665 82 22

fax +48 58 665 81 20

e-mail: velano@velano.eu

www.velano.eu
