

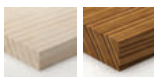

5394 FZ					HW		
ROZMIETACIE PÍLOVÉ KOTÚČE - 2 VYHADZOVAČE							
ø D	B	b	ø d	Z	Nr		
250	3,6	2,5	70 DKN	16+2	22194000250		
250	3,6	2,5	80 DKN	16+2	22194000251		
300	4	2,8	30	18+2	22194000300		
300	4	2,8	70 DKN	18+3	22194000301		
300	4	2,8	80 DKN	18+4	22194000302		
315	4	2,8	80 DKN	18+5	22194000315		
350	4	2,8	70 DKN	20+2	22194000350		
350	4	2,8	80 DKN	20+2	22194000351		
400	4	2,8	80 DKN	24+2	22194000400		

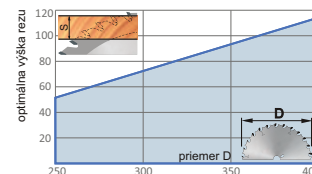

Rozmietacie pilové kotúče, štandardná kvalita rezu. Určené pre nižšie výšky rezu.



5394.1 FZ					HW		
ROZMIETACIE PÍLOVÉ KOTÚČE - 4 VYHADZOVAČE							
ø D	B	b	ø d	Z	Nr		
300	3,2	2,2	80 DKN	18+4	22194100300		
300	3,2	2,2	80 DKN	24+4	22194100301		
315	3,2	2,2	80 DKN	18+4	22194100315		
400	4	2,8	80 DKN	24+4	22194100401		
450	4,4	3,2	80 DKN	20+4	22194100450		
450	4,4	3,2	80 DKN	28+4	22194100451		
500	4,4	3,2	30	22+6	22194100500		
550	5	3,5	30	32+6	22194100550		



Rozmietacie pilové kotúče, štandardná kvalita rezu. Určené pre stredné výšky rezu.

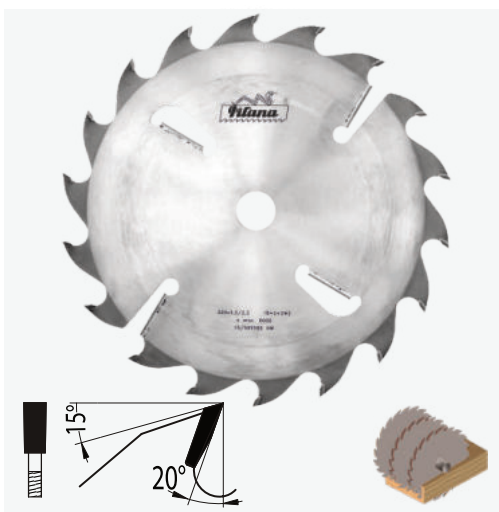
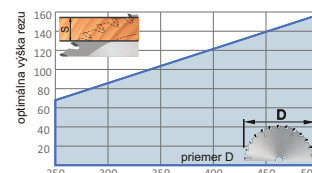

5394.1 MASSIVE FZ					HW		
ROZMIETACIE PÍLOVÉ KOTÚČE - STABIL							
ø D	B	b	ø d	Z	Nr		
300	4	2,8	30	18+2	221941M0300		
300	4	2,8	70 DKN	18+2	221941M0301		
300	4	2,8	80 DKN	18+2	221941M0302		
315	4	2,8	80 DKN	18+2	221941M0315		
350	4	2,8	30	20+4	221941M0350		
350	4	2,8	70 DKN	20+4	221941M0351		
350	4	2,8	80 DKN	20+4	221941M0352		
400	4,2	3	30	20+4	221941M0400		
400	4,2	3	80 DKN	20+4	221941M0401		
450	5	3,5	30	20+4	221941M0450		
500	5	3,5	30	22+6	221941M0500		
550	5,5	3,5	30	22+6	221941M0550		



Zosilnené rozmietacie pilové kotúče, štandardná kvalita rezu. Určené pre vyššie výkony a náročnejšie typy rezania.

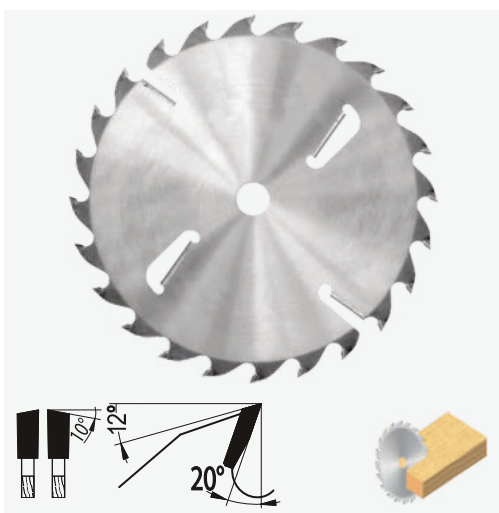
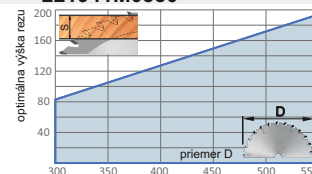

320 WZ					HW		
ROZMIETACIE PÍLOVÉ KOTÚČE PRE STOLOVÉ PÍLY							
ø D	B	b	ø d	Z	Nr		
250	3,2	2,2	30	20+2	6150320253020		
300	3,2	2,2	30	24+4	6150320303024		
350	3,5	2,5	30	28+4	6150320353028		
400	4	2,8	30	32+6	6150320403032		

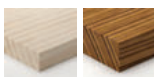

Rozmietacie pilové kotúče určené pre jednokotúčové píly. Vhodné na omietanie reziva na formátovacích pilách. Vyššia kvalita rezu.

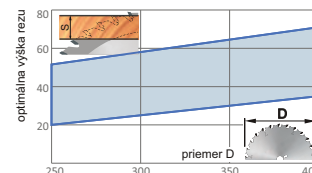

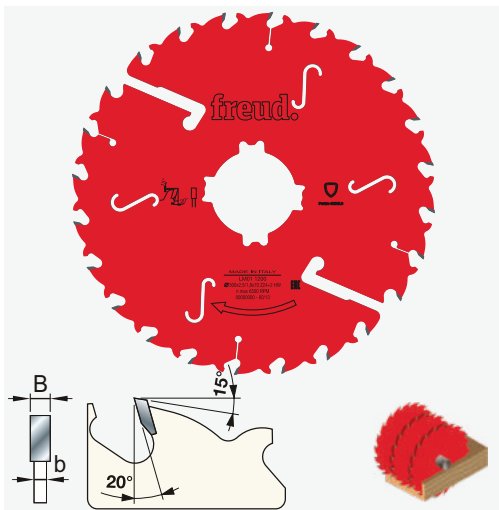

LM01 FZ						HW	freud
ROZMIETACIE PÍLOVÉ KOTÚČE - TENKÝ PREREZ							
ø D	B	b	ø d	Z	Nr		
180	2,2	1,6	40 DKN	16+2	280LM010100		
200	2,2	1,6	40 DKN	16+2	280LM010200		
225	2,2	1,6	70 DKN	16+2	280LM010500		
250	2,2	1,6	60 DKN	20+2	280LM010700		
300	2,5	1,8	60 DKN	24+2	280LM011100		
300	2,5	1,8	80 DKN	24+2	280LM011300		



Kotúče vhodné do rozmietačiek a štvorstranných frézo-vačiek. Určené pre sušené rezivo s maximálnou vlhkosťou 10-12%.

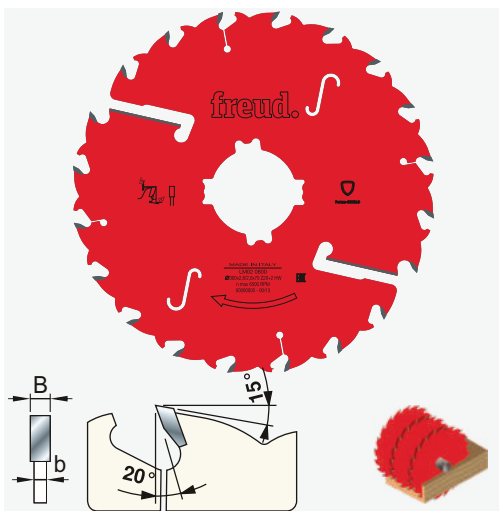
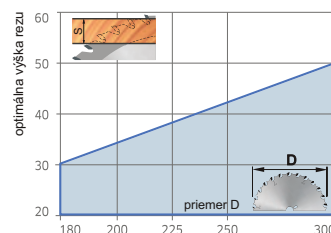

LM02 FZ						HW	freud
ROZMIETACIE PÍLOVÉ KOTÚČE - TENKÝ PREREZ							
ø D	B	b	ø d	Z	Nr		
250	2,8	2	30 DKN	16+2	280LM020100		
250	2,8	2	70 DKN	16+2	280LM020300		
300	2,8	2	30 DKN	20+2	280LM020600		
300	2,8	2	70 DKN	20+2	280LM020800		
350	3	2,2	30 DKN	24+4	280LM021200		



Kotúče vhodné do rozmietačiek a štvorstranných frézo-vačiek. Určené pre sušené rezivo s maximálnou vlhkosťou 15%.

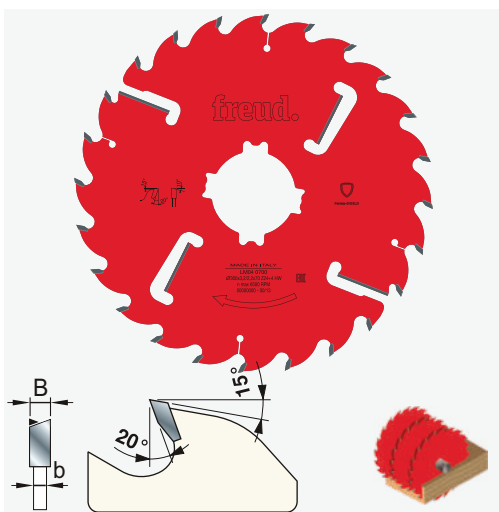
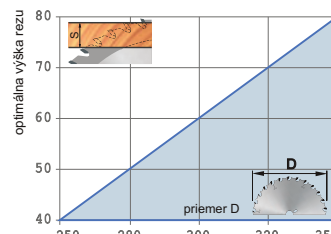

LM04 WZ						HW	freud
ROZMIETACIE PÍLOVÉ KOTÚČE - ŠTANDARD							
ø D	B	b	ø d	Z	Nr		
250	3,2	2,2	70 DKN	20+4	280LM040300		
250	3,2	2,2	80 DKN	20+4	280LM040400		
300	3,2	2,2	70 DKN	24+4	280LM040700		
300	3,2	2,2	80 DKN	24+4	280LM040800		
350	3,5	2,5	70 DKN	24+6	280LM042400		
350	3,5	2,5	80 DKN	24+6	280LM042500		
400	4	2,8	70 DKN	28+6	280LM041600		
400	4	2,8	80 DKN	28+6	280LM041700		



Pílové kotúče do rozmietačiek. Určené pre sušené rezivo s maximálnou vlhkosťou do 15%.

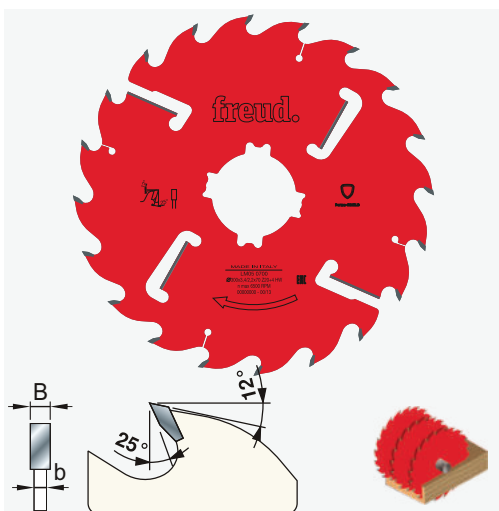
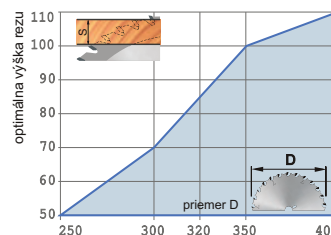

LM05 FZ						HW	freud
ROZMIETACIE PÍLOVÉ KOTÚČE - ŠTANDARD							
ø D	B	b	ø d	Z	Nr		
250	3,4	2,2	30 DKN	16+4	280LM050100		
300	3,4	2,2	30 DKN	20+4	280LM050500		
300	3,4	2,2	70 DKN	20+4	280LM050700		
300	3,4	2,2	80 DKN	20+4	280LM050800		
350	3,7	2,5	30 DKN	20+6	280LM051100		
350	3,7	2,5	70 DKN	20+6	280LM051400		
350	3,7	2,5	80 DKN	20+6	280LM051500		
400	4	2,8	30 DKN	24+6	280LM051900		
400	4	2,8	80 DKN	24+6	280LM052100		
450	4,4	3	30 DKN	24+6	280LM052400		
500	4,8	3,5	30 DKN	28+6	280LM052900		
500	4,8	3,5	30 DKN	28+6	280LM052901		
500	4,8	3,5	50 DKN	28+6	280LM053000		
550	4,8	3,5	30 DKN	28+6	280LM053400		



Pílové kotúče do rozmietačiek. Určené na tvrdé aj mäkké dreveniny s vlhkosťou nad 10%.