

SUPERPROFIL TSP 154

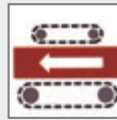

- priemyselné superprofilové hlavy pre strojný posuv
- nasadzovanie do spodných frézovačiek

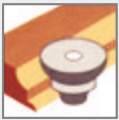
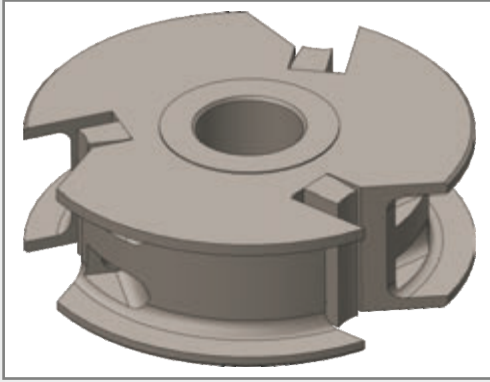
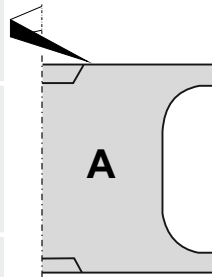
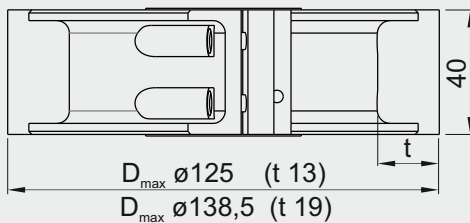
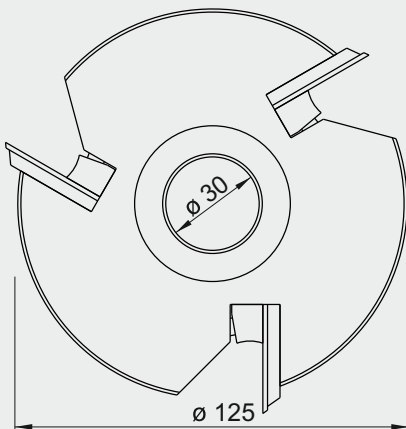

TYP	ø D	ø d	Z	Nr
A	125	30	3	280TSP154A

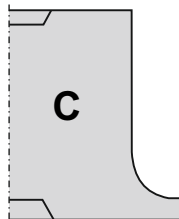

TYP	ø D	ø d	Z	Nr
C	125	30	3	280TSP154C

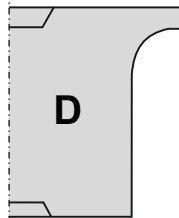

TYP	ø D	ø d	Z	Nr
D	125	30	3	280TSP154D

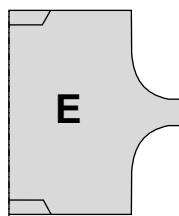

TYP	ø D	ø d	Z	Nr
E	125	30	3	280TSP154E

