

YH152AAM YH156AAM

MAN | HW

TESTE PER GIUNZIONI LUNGO VENA O TRAVERSO VENA CUTTERHEADS FOR ALONG OR ACROSS THE GRAIN JOINTS VERLEIMPROFILFRÄSER



Utensile a due taglienti con corpo in lega leggera e coltelli in HW. Adatto per realizzare giunzioni lungo e trasverso vena da 20 a 48 mm e da 26 a 58 mm. YH152AAM: giunzioni lungo vena. YH156AAM: giunzioni trasverso vena.

Light alloy body, standard tungsten carbide profiled knives for high precision jointing of hardwood and softwood, chip thickness limitation and reduced recoil, suitable for manual feed. YH152AAM: along the grain joints. YH156AAM: across the grain joints.

Anwendung

Für Verleimverbindungen in Hart- und Weichhölzern mit Holzstärken von 20-48 mm und 26-58 mm.

Technische Daten

Werkzeugkörper aus hochfestem Aluminium, konstanter Flugkreis und exakte Profiltreue durch Standard-Hartmetall-Profilplatten, spandickenbegrenzt und rückschlagarm, für Handvorschub geeignet. YH152AAM: Längsschnitt. YH156AAM: Querschnitt.

Ø D [mm]	B [mm]	Ø d [mm]	Z	V	RPM min-max	Art. Nr.	€
125	50	30 (-50)	2	-	6100 - 10600	① YH152AAM	
125	60	30 (-50)	3	-	6100 - 10600	② YH156AAM	

Giunzioni lungo vena
Along the grain joints
Längsschnitt

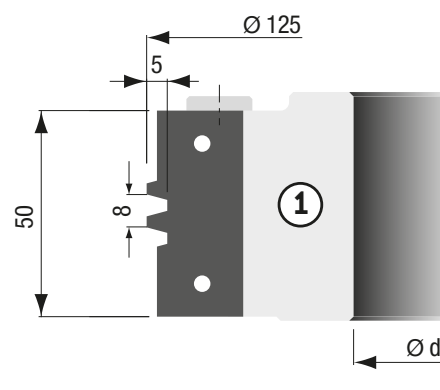
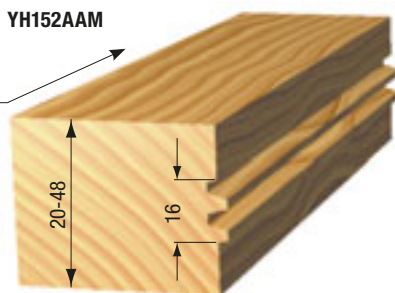

YH152AAM

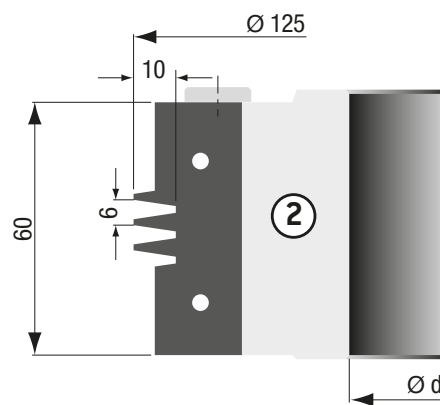
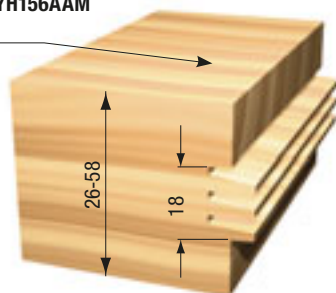

Giunzioni trasverso vena
Across the grain joints
Querschnitt

YH156AAM



Ricambi / Spare Parts / Ersatzteile				
YH152AAM ①	Art. Nr.	605002	340011	501403
	Dim.	50x19x2	48	M8x16
	Pcs	2	2	10
	€			
YH156AAM ②	Art. Nr.	605004	340041	501403
	Dim.	60x24x2	58	M8x16
	Pcs	3	3	10
	€			