

minimax *line*

genius range



joinery machines

REV. N. 01 - 03.2021 - MIG STUDIO



SCM GROUP SPA
via Casale 450 - 47826 Villa Verucchio, Rimini - Italy
tel. +39 0541 674111 - fax +39 0541 674274
scm@scmgroup.com
www.scmwood.com



00L0593186C



All “Made in SCM Italy”

From casting iron to finished product.

Come see our production plants and touch the quality of SCM machines; you will be our guest.



minimax

the passion that deserves professional products.

minimax is the line of professional machines for hobbyists and woodworkers, a point of reference for over 40 years worldwide. SCM's objective is to guarantee customers high quality technologies which meet their requirements in such a way as to make SCM the partner for any needs.

genius

All the minimax quality at the more accessible price.

universal combined machines

c 30g
page 6



c 26g
page 7



combined machines

fs 30g
page 8



st 1g
page 8



circular saw

sc 1g
page 9





App Thundercut

Technology at your fingertips

SCM Thundercut is the Optimizer/Sequencer App for mobile devices, that allows to optimize the panel surface and guides the operator through the cutting sequence.

High cut speed execution, less material waste and mistake odds minimized, even for not skilled workers!

Download it now from the AppStore and Google Play:

SCM Thundercut  

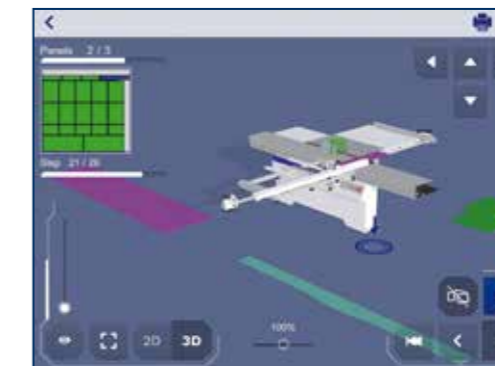
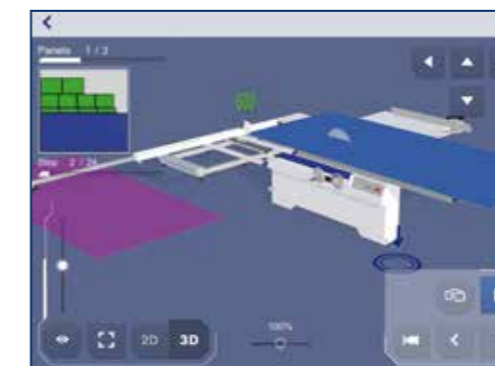
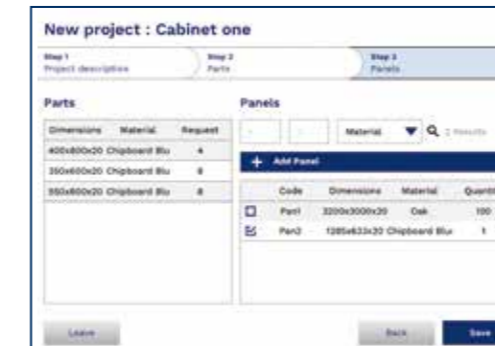
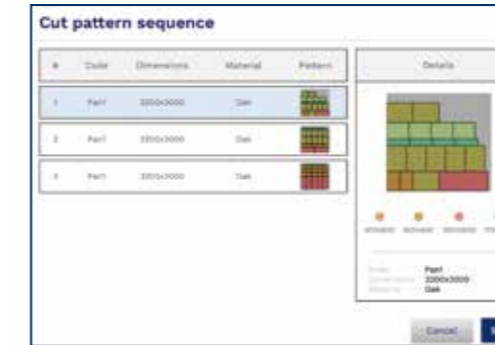

You can manage your circular saws fleet, the material warehouse and many project you are working on.

The 3D sequencer, thanks to its simple and clear design, suggest the ideal settings of the machine for every single cut to be executed.

The App is available for circular saws, circular saws with movable blade unit, saw-shaper combination machines and universal combination machines (you will find the QR code to activate the App in each new machine).



genius
universal
combined machines
c 30g
c 26g



		c 30g	c 26g
Planer useful working width	mm	300	260
Total length of surfacing tables	mm	1200	1040
Max. saw blade diameter	mm	250	250
Squaring stroke	mm	1200	1200
Max. spindle length	mm	75	75
Three-phase motors starting from	kW/Hz	1,8 (2,2) / 50 (60)	1,8 (2,2) / 50 (60)

Find the complete technical specification at page 12



Saw Unit
cutting precision



Surfacing Planer
fully equipped



Thickening Planer
practical and ergonomic



Spindle Moulder
flexibility



Mortiser
functional



SCM Thundercut
Optimizer/
Sequencer App

The practical and compact woodworking machines with all the Minimax quality at the more accessible price, ideal for demanding DIY woodworkers and craftsmen.

genius
combined machines
circular saw
fs 30g
st 1g
sc 1g

surfacing-thicknessing planer
saw-spindle moulder
circular saw



		fs 30g	st 1g	sc 1g
Planer useful working width	mm	300	-	-
Total length of surfacing tables	mm	1200	-	-
Max. saw blade diameter	mm	-	250	250
Squaring stroke	mm	-	1200	1200
Max. spindle length	mm	-	75	-
Three-phase motors starting from	kW/Hz	1,8 (2,2) / 50 (60)	1,8 (2,2) / 50 (60)	1,8 (2,2) / 50 (60)

Find the complete technical specification at page 12



Saw Unit
cutting precision



Surfacing Planer
fully equipped



Thicknessing Planer
practical and ergonomic



Spindle Moulder
flexibility



Mortiser
functional



SCM
Thundercut
Optimizer/
Sequencer App

genius operating groups



cutting precision

Saw Unit.

Tilting saw unit with a 250 mm blade and a maximum blade projection from table at 90° of 80 mm. The saw unit can be raised and tilted using convenient hand-wheels. The anodized aluminum sliding table, with a 1200 mm stroke, slides **next to the blade**, thus ensuring better cutting precision.

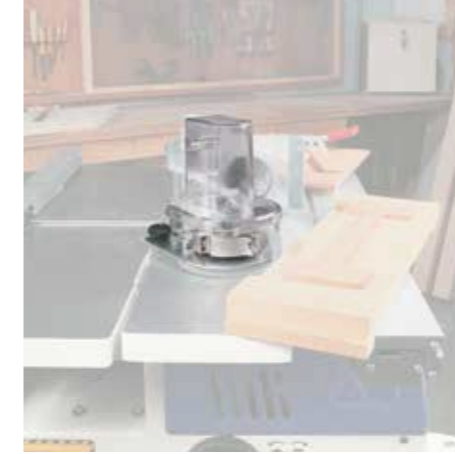

safety first

Genius machines have many **safety devices according to CE norms**, as like as the spindle moulder guard for curved profiles and moulding shapes.



fully equipped

Surfacing Planing.

The planer unit has a cutter block with 2 re-usable knives (the "Tersa" disposable knives system with 3 knives and rapid clamping is available as an option). Genius machines also have saw-planer fences with an anodized aluminum extrusion and a support with clamp for fast positioning.

practical and ergonomic

Thickening Planing.

To keep the machine compact and make machining easier, the surfacing table opens towards the inside of the machine. Thanks to an efficient feed system, the thickening unit can process wood up to 200 mm thick.



functional and customisable

A machine even more versatile: with the practical **mortiser** (option) drilling holes or mortises are easily done.

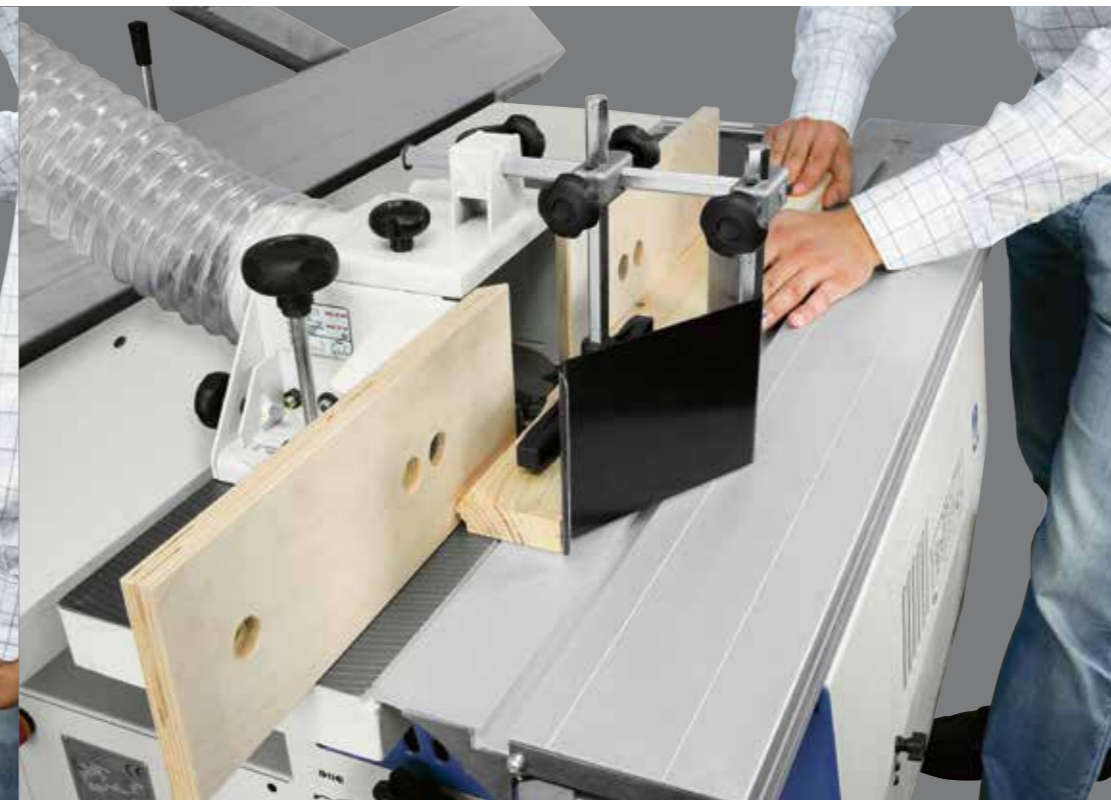

flexibility

Spindle Moulder.

Maximum flexibility in spindle moulder tool use, with the unit with 2 speed (5000/7500 rpm). The machines have a spindle moulder fence with micrometric adjustment, a feature which is particularly useful on profiling jobs. Tenoning is easy too, thanks to the aluminum sliding table, the right speed setting and the special protection hood (option).

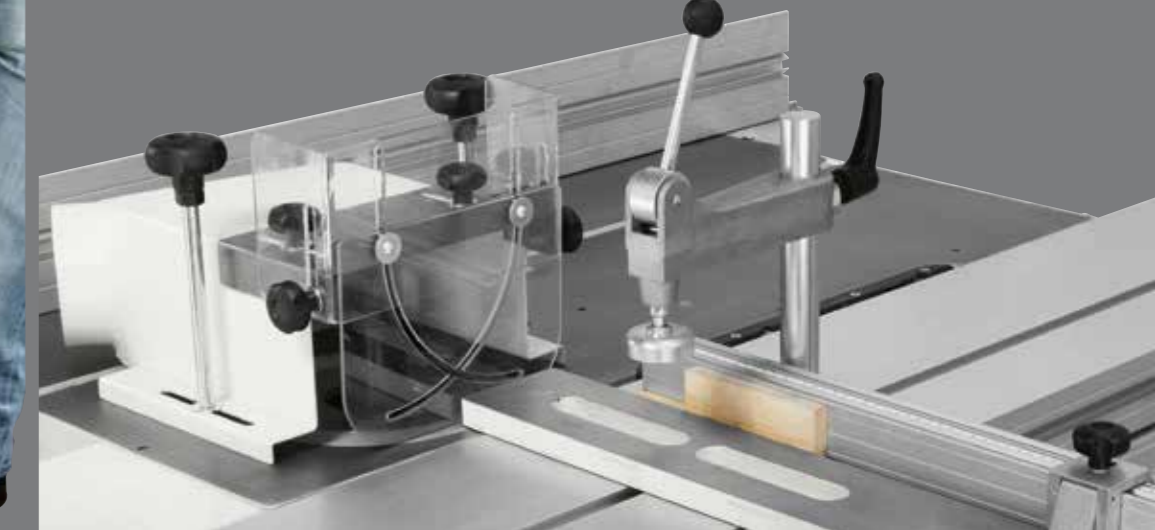

genius dimensions and technical data

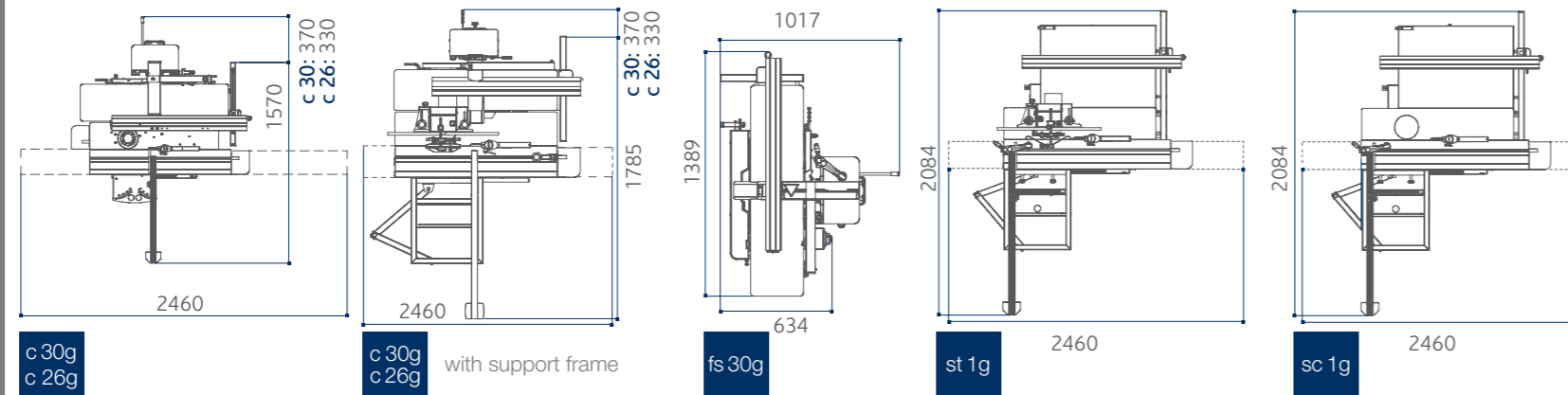

S Standard
O Option

	c 30g	c 26g	fs 30g	st 1g	sc 1g
planer					
Working width	mm	300	260	300	-
Cutter block diameter (mm)/no. of standard knives	mm/n.	62 / 2	62 / 2	62 / 2	-
Dimensions of standard knives	mm	300 x 25 x 3	260 x 25 x 3	300 x 25 x 3	-
Max. stock removal	mm	3	3	3	-
Surfacing tables total length	mm	1200	1040	1200	-
Thicknessing table dimensions	mm	300 x 450	260 x 450	300 x 450	-
Feed speed on thicknesser	m/min	6	6	6	-
Min. ÷ max. working height on thicknesser	mm	3 ÷ 200	3 ÷ 200	3 ÷ 200	-
circular saw					
Cast iron saw-spindle moulder worktable dimensions	mm	1024 x 224	1024 x 224	-	1024 x 224
Saw blade tilting		90° ÷ 45°	90° ÷ 45°	-	90° ÷ 45°
Max. saw blade diameter with scoring blade installed	mm	250	250	-	250
Max. saw blade projection from table at 90°/45°	mm	80 / 64	80 / 64	-	80 / 64
Squaring stroke	mm	1200	1200	-	1200
Cutting width on parallel fence	mm	540	500	-	700
spindle moulder					
Max. useful spindle length	mm	75	75	-	75
Spindle moulder speeds (at 50 Hz)	rpm	5000 / 7500	5000 / 7500	-	5000 / 7500
Max. tool diameter when profiling	mm	160	160	-	160
Max. diameter of tool lowered under the table at 90°	mm	145	145	-	145
Max. tool diameter when tenoning	mm	200	200	-	200
other technical features					
Three-phase motors 1,8 kW (2,5 hp) 50 Hz – 2,2 kW (3 hp) 60 Hz		S	S	S	S
Three-phase motors 2,2 kW (3 hp) 50 Hz – 2,6 kW (3,6 hp) 60 Hz		O	O	O	O
Single-phase motors 1,8 kW (2,5 hp) 50 Hz		O	O	O	O
Single-phase motors S1 1,8 kW (2,5 hp) 60 Hz		O	O	O	O
Exhaust outlets diameter	mm	120	120	120	120



genius main optional devices

tablet holder
on the sliding
carriage
Compatible with
tablets from
8" to 11".



"minimax ease"
mobile trolley
for accessories
Designed to store various
accessories such as:
surfacing fence, squaring
fence, spindle moulder
fence, spindle shafts, etc.



genius main optional devices

"Tersa" cutter block
Automatic knives clamping by
means of the centrifugal force
ensures safe and precise machining.
The system, without fixing screws,
makes knives substitution
extremely fast.



self-centering chuck
0-16 mm "Wescott" type
The mortiser spindles can be rapidly
substituted without the necessity
of adjustment.



tenoning table and
protection hood
For the tenoning operations on the spindle
moulder. It consists of:
- table
- protection hood for tools,
200 mm diameter
- exhaust hood, 120 mm diameter



S Standard
O Option

maintenance case for
"Xylent" spiralknife

- Complete with:
- 1 cleaning/degreasing liquid bottle for the resins cleaning
 - 1 set dynamometric key
 - 2 bit Torx
 - 10 inserts
 - 5 screws
 - 1 brass bristle brush to clean the spindle with mounted in inserts
 - 1 steel bristle brush to clean the inserts housings



"Xylent" spiralknife cutter block
with 3 series of knives

The 3 spiralknives give an exceptional finish. Reduced noise during machining provides a more comfortable working environment. It also improves the dust extraction due to the production of very small chips. Each cutter has 4 tips which can be rotated into the cutting position when worn. Therefore increasing the production life of the cutter block before knives require replacement.

	c 30g	c 26g	fs 30g	st 1g	sc 1g
"SCM Thundercut" Optimizer/Sequencer App	S	S	-	S	S
Tablet holder on the sliding carriage	O	O	-	O	O
"Tersa" cutter block	O	O	O	-	-
"Xylent" spiralknife cutter block with 3 series of knives	O	O	O	-	-
Maintenance case for "Xylent" spiralknife	O	O	O	-	-
Self-centering chuck 0-16 mm "Wescott" type	O	O	O	-	-
Tenoning table and protection hood	O	O	-	O	-

PROMPT AND EXPERT TECHNICAL SUPPORT THROUGH A NETWORK OF 1000 TECHNICIANS AND AN INVENTORY OF 36,000 SPARE PARTS.

HIGHLY SPECIALISED TECHNICIANS, EFFICIENT MANAGEMENT AND 6 SPARE PARTS BRANCHES AROUND THE WORLD GUARANTEE A CLOSE, SAFE AND EFFECTIVE TECHNICAL SUPPORT.

SERVICE

SCM provides a service that goes beyond the purchase, to guarantee the long term performance of your technological production system and peace of mind for your business.

A COMPLETE RANGE OF AFTER-SALES SERVICES

- installation and start-up of machines, cells, lines and systems
- tailored training programs
- telephone support to reduce times and costs when machines are not working
- preventive maintenance programs to guarantee long term performance
- complete renovation of machines and plants to renew the added value of the investments
- custom upgrading to update machines and plants and meet new production requirements



SPARE PARTS

SCM Group can count on 140 spare parts professionals worldwide to meet any request with real time shipments.



36,000 SPARE PARTS

Our spare parts inventory, with a value of 12 million euros, covers every single machine



SPARE PARTS GUARANTEED

We guarantee also hard to find parts, with 3,5 million euros invested in "critical" spare parts.



IMMEDIATE AVAILABILITY

Over 90% of orders received are carried out the same day thanks to the huge inventory available.



6 BRANCHES AROUND THE WORLD

The spare parts service can count on worldwide support (Rimini, Singapore, Shenzhen, Moscow, Atlanta, São Bento do Sul)



500 SHIPMENTS A DAY



THE STRONGEST WOOD TECHNOLOGIES ARE IN OUR DNA

SCM. A HERITAGE OF SKILLS IN A UNIQUE BRAND

Over 65 years of success gives SCM the centre stage in woodworking technology. This heritage results from bringing together the best know-how in machining and systems for wood-based manufacturing. SCM is present all over the world, brought to you by the widest distribution network in the industry.

65+ years history

3 main production sites in Italy

300.000 square metres of production space

20.000 machines manufactured per year

90% export

20 foreign branches

400 agents and dealers

500 support technicians

500 registered patents

In SCM's DNA also strength and solidity of a great Group. The SCM Group is a world leader, manufacturing industrial equipment and components for machining the widest range of materials.

SCM GROUP, A HIGHLY SKILLED TEAM EXPERT IN INDUSTRIAL MACHINES AND COMPONENTS

INDUSTRIAL MACHINERY

Stand-alone machines, integrated systems and services dedicated to processing a wide range of materials.



WOODWORKING TECHNOLOGIES



TECHNOLOGIES FOR PROCESSING COMPOSITE MATERIALS, ALUMINIUM, PLASTIC, GLASS, STONE, METAL

INDUSTRIAL COMPONENTS

Technological components for the Group's machines and systems, for those of third-parties and the machinery industry.



SPINDLES AND TECHNOLOGICAL COMPONENTS



ELECTRIC PANELS



METALWORK



CAST IRON





Company of the Scm Group
registered office:
via Emilia, 77
47921 Rimini, Italia
T. +39 0541 700111
F. +39 0541 700232
sales office:
via Casale, 450
47826 Villa Verucchio, Rimini, Italia
T. +39 0541 674111
F. +39 0541 674274
scm@scmgroup.com
www.scmwood.com

Scm Industria Spa
Professional Workshop Machinery
via Valdicella, 7
47892 Gualdicciolo,
Repubblica di San Marino
scm@scmgroup.com
sales dept. Italy:
T. +378 0549 876911
F. +378 0549 999604
foreign sales dept.:
T. +39 0541 674111
F. +39 0541 674274
www.scmwood.com

The motors powers in this catalogue are expressed in S6,
except where otherwise specified. In this catalogue, machines
are shown in CE configuration and with options. We reserve
the right to modify technical specifications without prior
notice, provided that such modifications do not affect
safety as per CE norms.

rev.01
03/2021

Mic Studio

