

**HW**

**MEC**

n max 7000

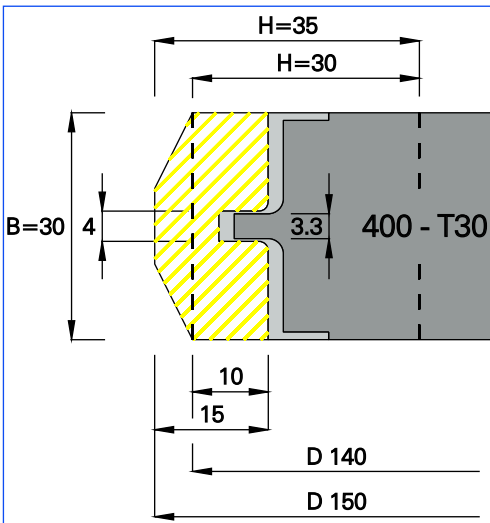

 AREA PROFILABILE / PROFILING AREA

ART.	D 2	B 1	d	Z	COD.
400 - T30	129	30	30	3	0400T30030
	129	30	31.75	3	0400T30031
	129	30	35	3	0400T30035
	129	30	40	3	0400T30040
	129	30	50	3	0400T30050
ART.	B	H	a	COD.	
401 - P	30	30	5	0401P30305	
	30	35	5	0401P30355	
ART.	B	H	a	COD.	
402 - P	30	30	2	0402P30302	
	30	35	2	0402P30352	
ART.	B	H	a	COD.	
403 - P	30	30	3	0403P30303	
	30	35	3	0403P30353	

 Multi - profiles cutter heads.

 Cabezales multiperfiles.



Multiprofil - Messerköpfe.



Ricambi / Spare parts / Rechanges / Repuestos / Ersatzteile

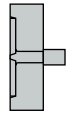

COD.  
04805128T0

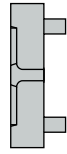

COD.  
04805138T0



COD.  
0480701020



COD.  
048073B000

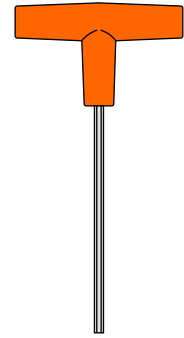



COD.  
048078L500

# 400

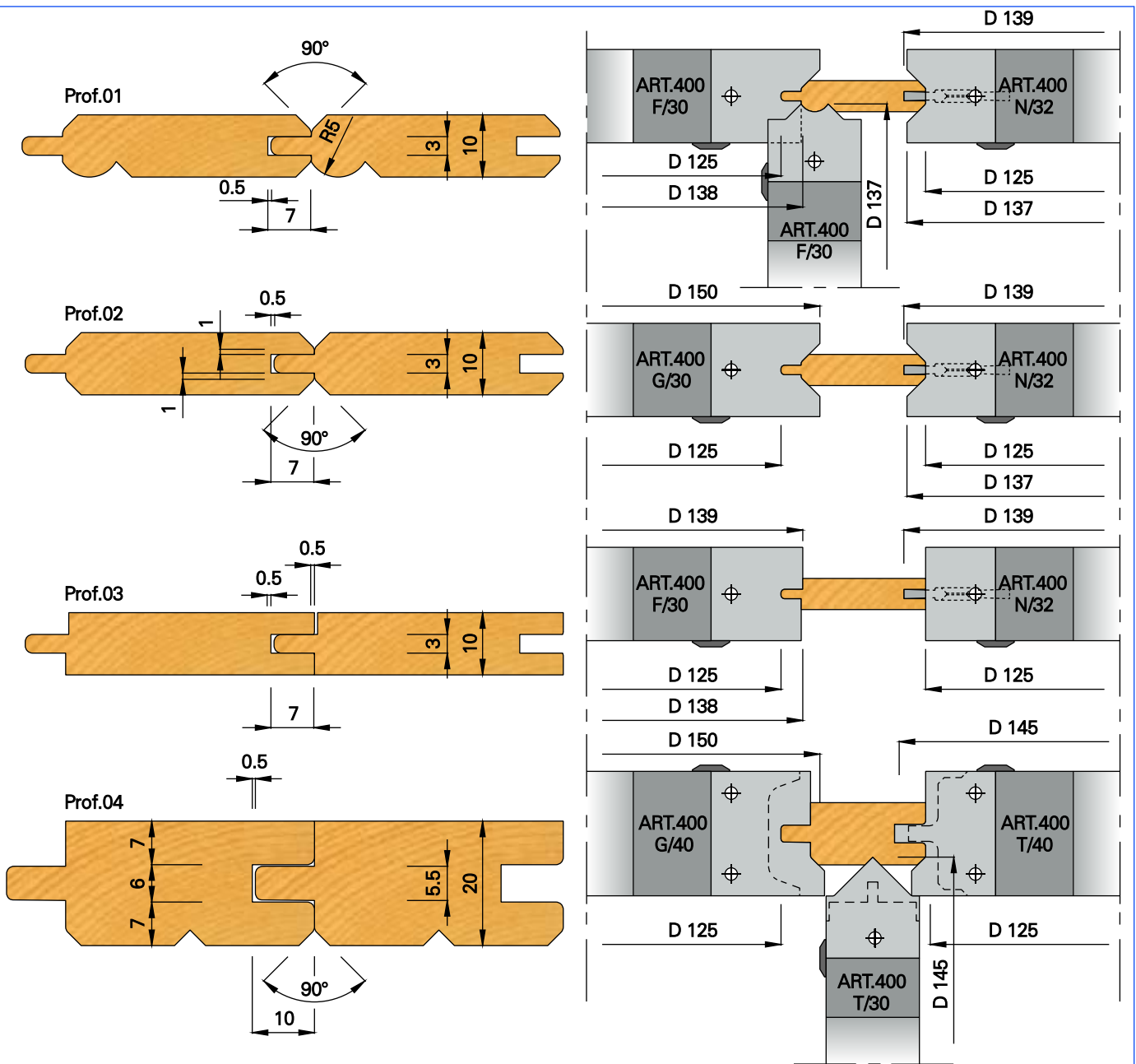
# Esempi di lavorazione



 Examples of workable profiles.

 Ejemplos de perfiles realizables.

 Exemples de profils réalisables.

 Durchführbaren Profilbeispiele.